



**STL**  
ALUMÍNIO

**LINHA**

**ESTRUTURA DE PALCO**

**PERFIL EXTRUDADO DE ALUMÍNIO**

**CATÁLOGO** Ver 1.0 | DEZ 24

PERFIL	MERCADO	KG/M	PÁG.
STL-0745	—	4,092	12
STL-0790	—	3,170	09
STL-0808	—	5,135	10
STL-0809	—	4,208	13
STL-0844	—	0,922	07
STL-0992	—	1,579	11
STL-0993	—	2,123	05
STL-1097	—	1,721	07
STL-1098	—	0,831	04
STL-1099	—	0,942	04
STL-1100	—	1,635	05
STL-1101	—	2,508	06
STL-1102	—	1,300	03
STL-1103	—	2,611	03
STL-1122	—	1,382	14
STL-1123	—	1,944	11
STL-1780	—	1,040	08
STL-1815	—	2,486	15

**STL-1102**

Merc. -----

Peso 1,300 kg/m

Descr. -----

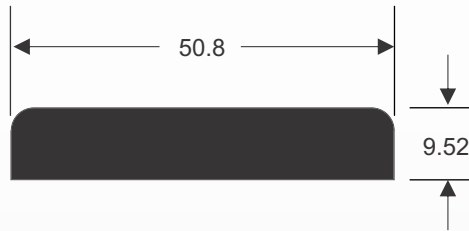

**STL-1103**

Merc. -----

Peso 2,611 kg/m

Descr. -----

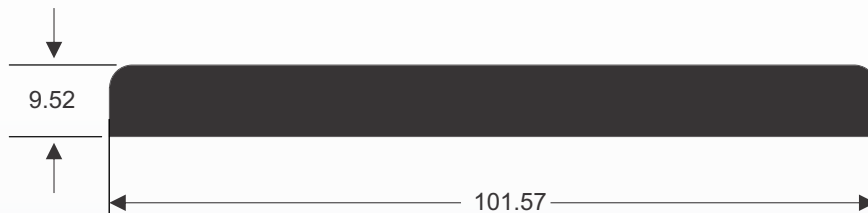

**STL-1099**

Merc. -----

Peso 0,942 kg/m

Descr. -----

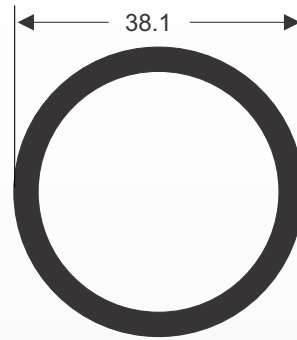

**STL-1098**

Merc. -----

Peso 0,831 kg/m

Descr. Folha

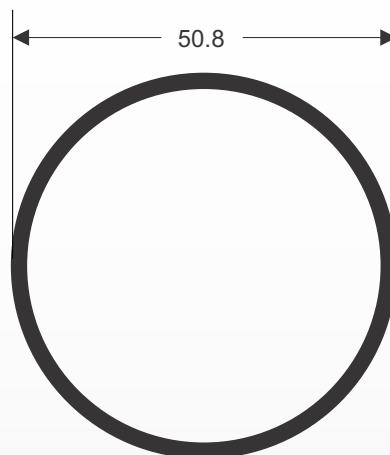

**STL-1100**

Merc. -----

Peso 1,635 kg/m

Descr. Folha

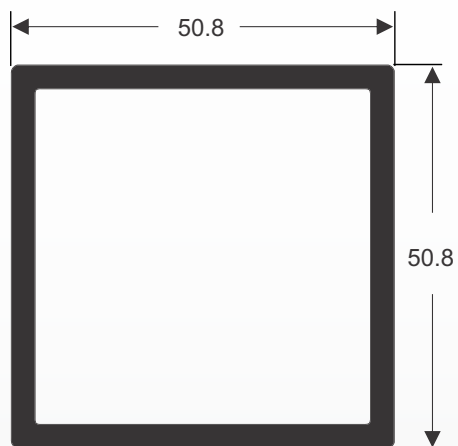

**STL-0993**

Merc. -----

Peso 2,123 kg/m

Descr. -----

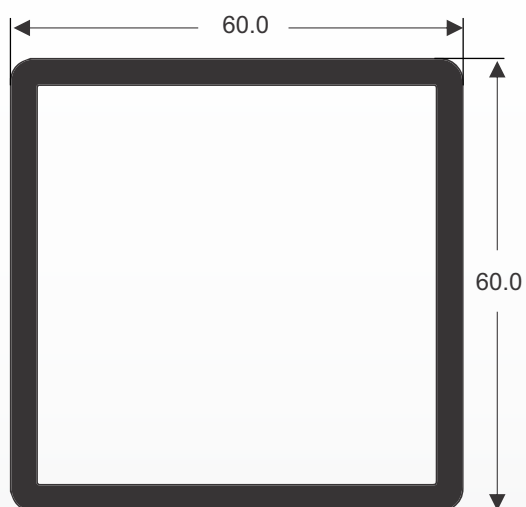

**STL-1101**

Merc. -----

Peso 2,508 kg/m

Descr. -----

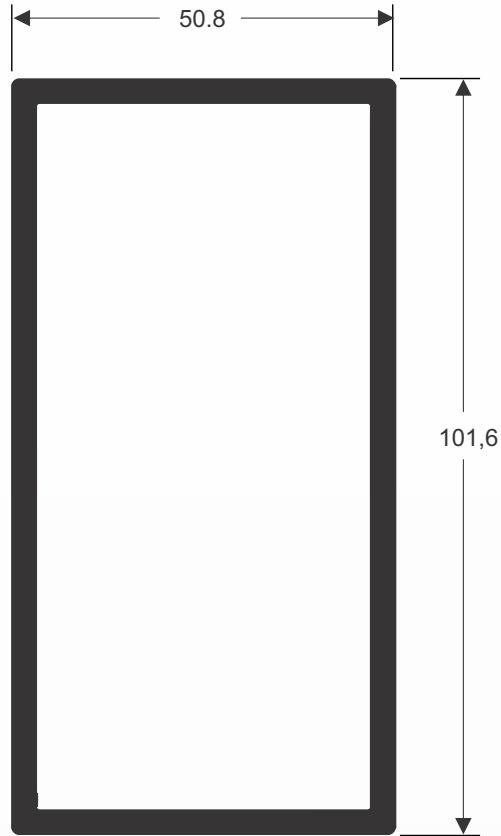

**STL-0844**

Merc. -----

Peso 0,922 kg/m

Descr. -----

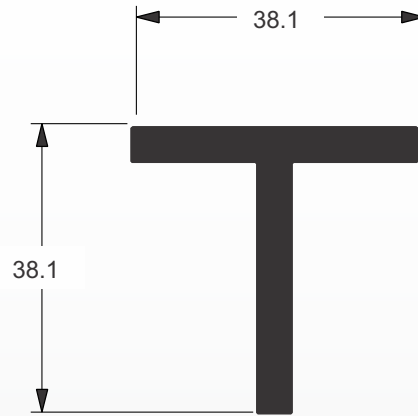

**STL-1097**

Merc. -----

Peso 1,721 kg/m

Descr. -----

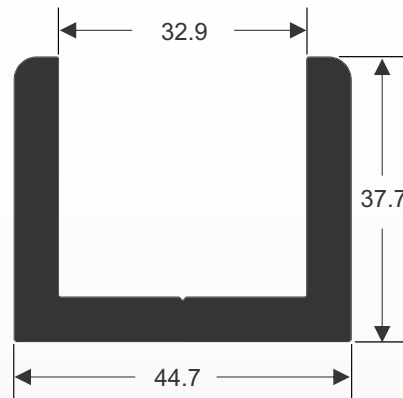

**STL-1780**

Merc. -----

Peso 1,040 kg/m

Descr. -----

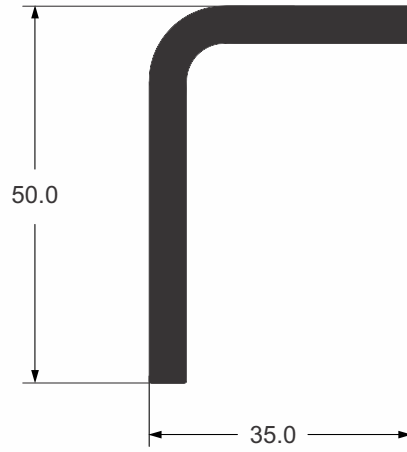



STL-0790

Merc. -----

Peso 3,170 kg/m

Descr. -----

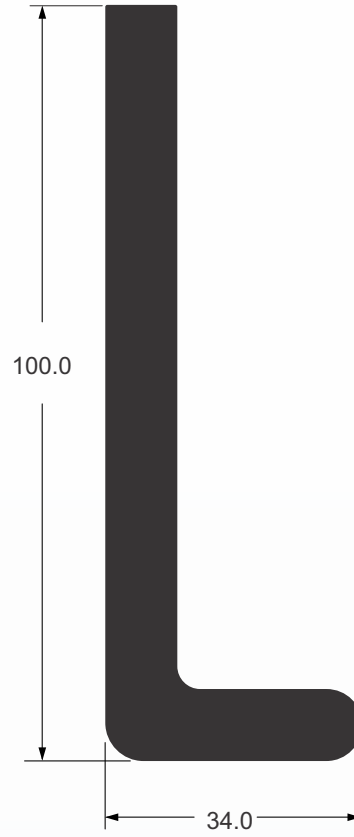

**STL-0808**

Merc. -----

Peso 5,135 kg/m

Descr. -----

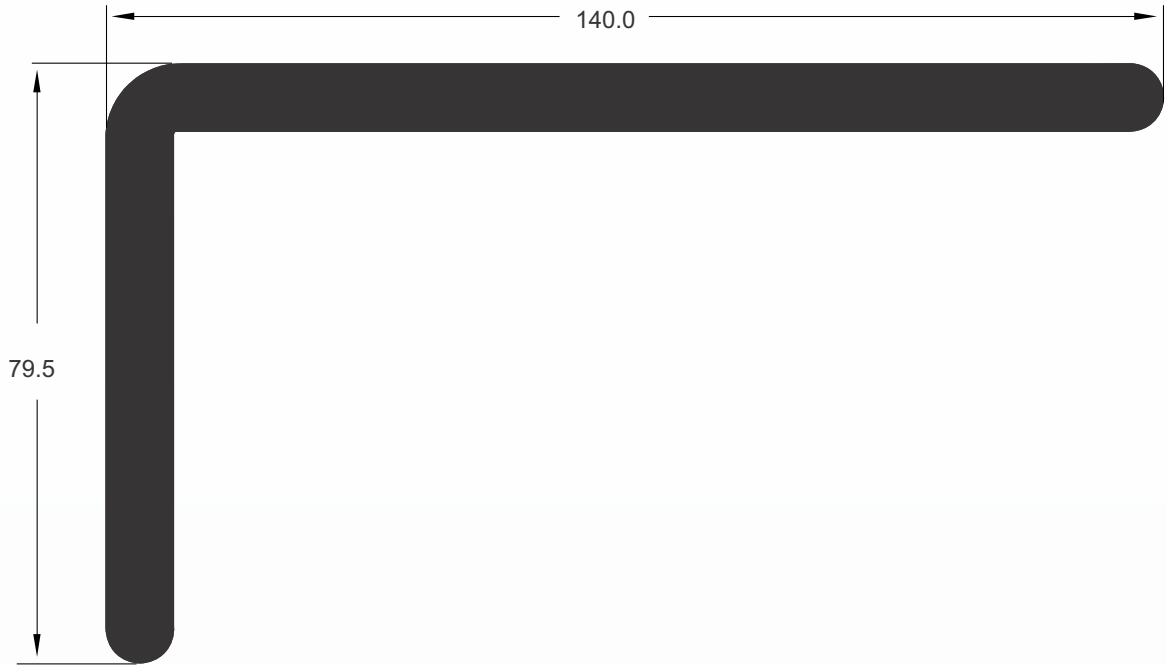

**STL-0992**

Merc. -----

Peso 1,579 kg/m

Descr. -----

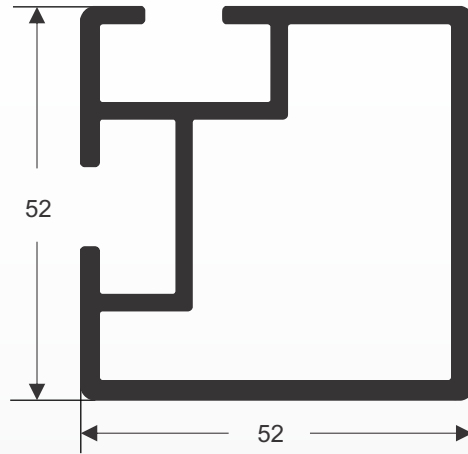

**STL-1123**

Merc. -----

Peso 1,944 kg/m

Descr. -----

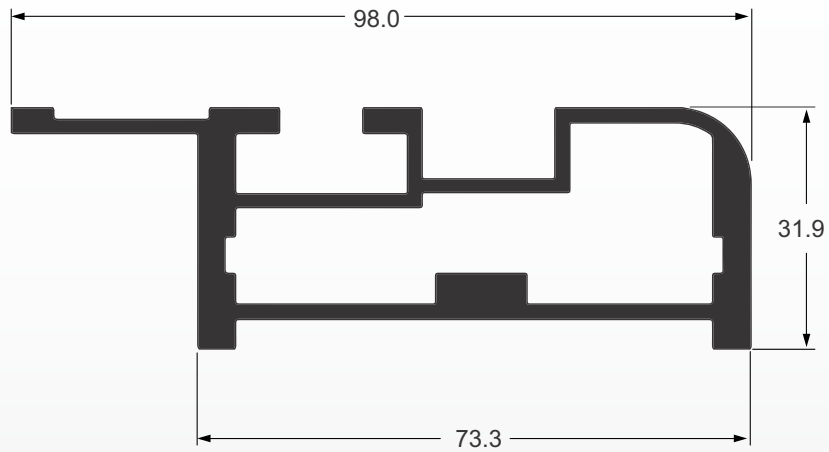

STL-0745

Merc. -----

Peso 4,092 kg/m

Descr. -----

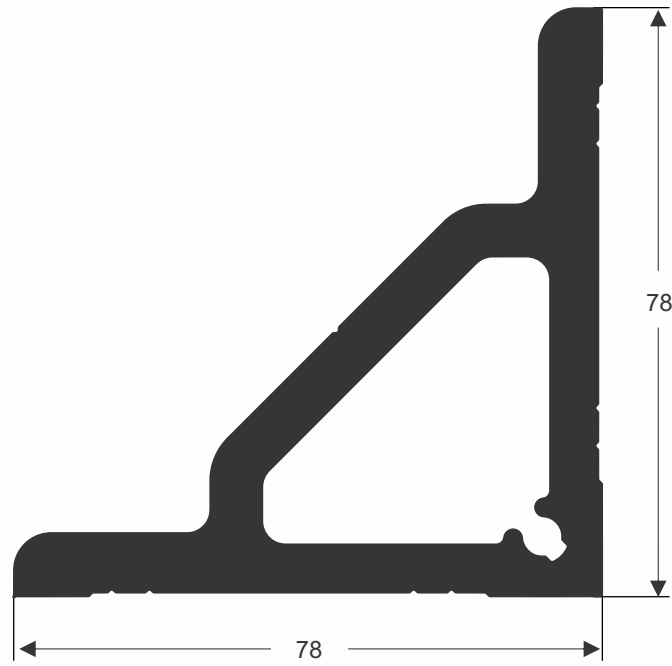

STL-0809

Merc. -----

Peso 4,208 kg/m

Descr. -----

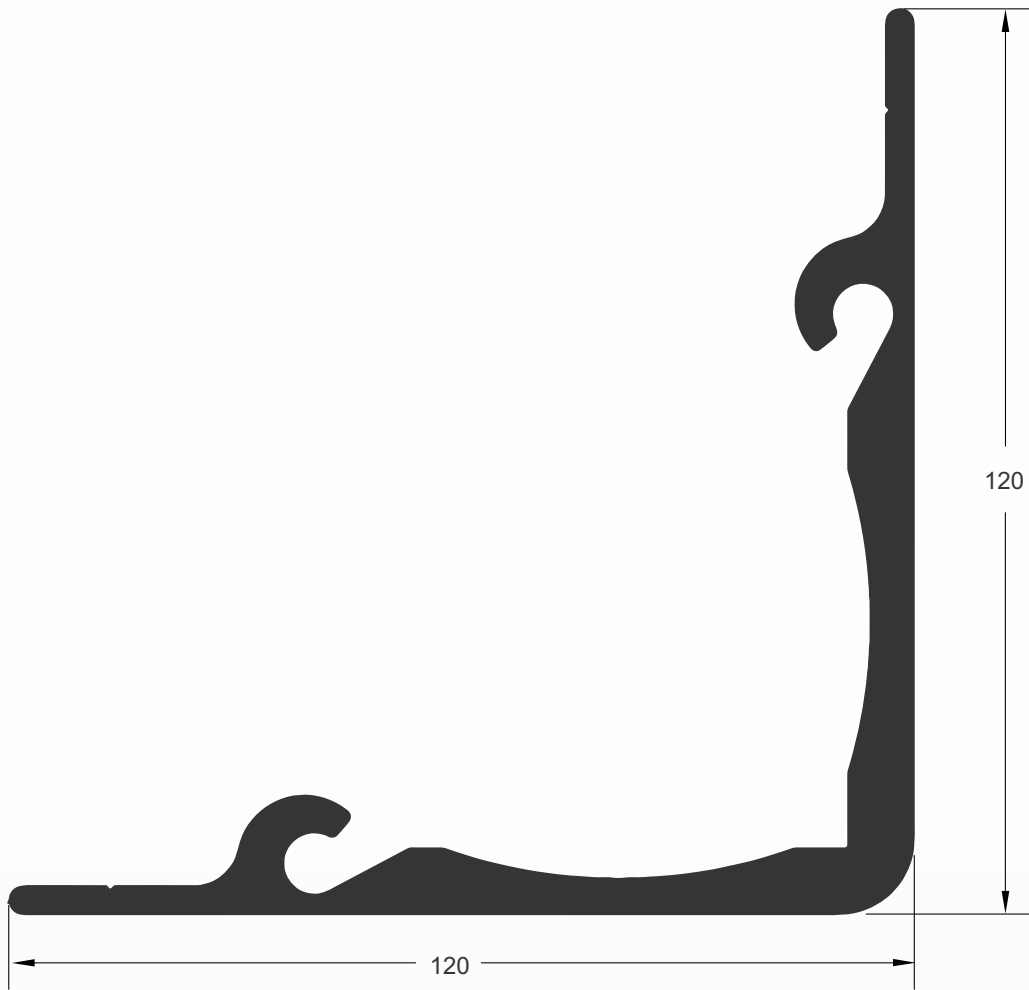

STL-1122

Merc. -----

Peso 1,382 kg/m

Descr. -----

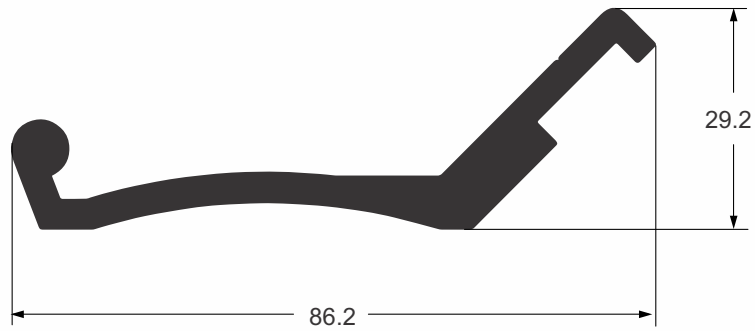

**STL-1815**

Merc. -----

Peso 2,486 kg/m

Descr. -----

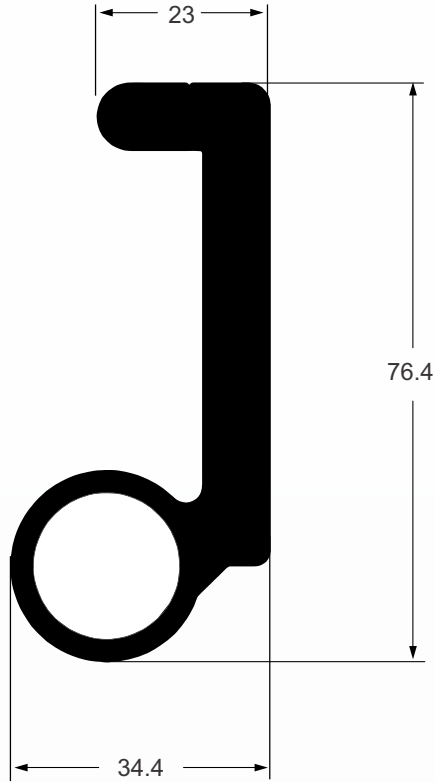



**STL**  
ALUMÍNIO



[stlaluminio.com.br](http://stlaluminio.com.br)



Av. Industrial, 1500 - Distrito Industrial - CEP 08586-150  
Itaquaquecetuba - SP - Tel.: 55+ 11 4233-9012