



**STL**  
ALUMÍNIO

**LINHA**

**POLICARBONATO  
TOLDOS**

**PERFIL EXTRUDADO DE ALUMÍNIO**

**CATÁLOGO** Ver 1.0 | DEZ 24

PERFIL	MERCADO	KG/M	PÁG.
STL-0026	—	0,309	09
STL-0125	—	0,762	09
STL-0126	—	0,328	04
STL-0127	—	0,393	08
STL-0128	—	0,525	09
STL-0147	—	0,490	08
STL-0166	—	0,430	08
STL-0217	—	0,502	08
STL-0221	—	0,510	07
STL-0337	—	0,238	05
STL-0639	—	0,194	05
STL-0640	—	0,132	03
STL-0641	—	0,140	03
STL-0642	—	0,152	03
STL-0643	—	0,252	06
STL-0644	—	0,178	06
STL-0645	—	0,249	06
STL-0646	—	0,285	04
STL-0721	—	1,279	12
STL-0728	—	0,307	08
STL-1041	—	1,068	10
STL-1042	—	1,141	11
STL-1332	—	0,878	13
STL-1333	—	1,043	13
STL-1334	—	3,989	13
STL-1348	—	0,248	06
STL-1349	—	0,195	03
STL-1350	—	0,429	05

**STL-0640**

Merc. -----

Peso 0,132 kg/m

Descr. -----

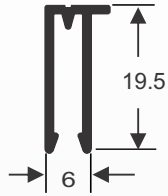

**STL-0641**

Merc. -----

Peso 0,140 kg/m

Descr. Folha

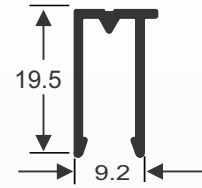

**STL-0642**

Merc. -----

Peso 0,152 kg/m

Descr. -----

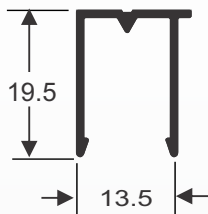

**STL-1349**

Merc. -----

Peso 0,195 kg/m

Descr. -----

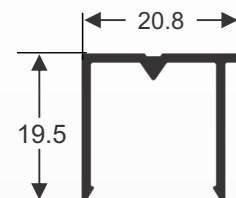

**STL-0126**

Merc. -----

Peso 0,328 kg/m

Descr. -----

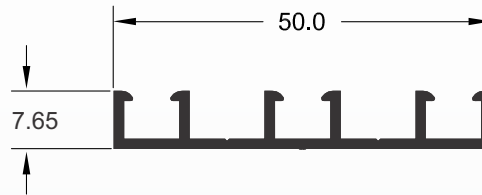

**STL-0646**

Merc. -----

Peso 0,285 kg/m

Descr. -----



**STL-0337**

Merc. -----

Peso 0,238 kg/m

Descr. -----

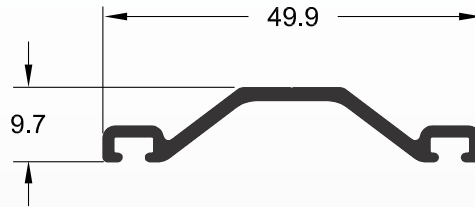

**STL-0639**

Merc. -----

Peso 0,194 kg/m

Descr. -----

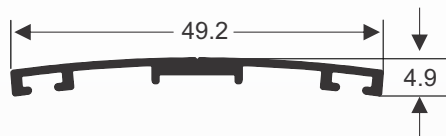

**STL-1350**

Merc. -----

Peso 0,429 kg/m

Descr. -----

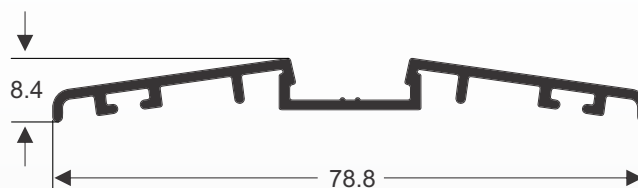

**STL-0644**

Merc. -----

Peso 0,178 kg/m

Descr. -----

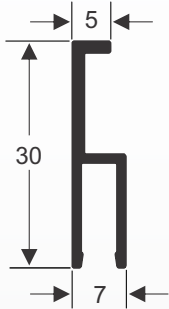

**STL-0645**

Merc. -----

Peso 0,249 kg/m

Descr. Folha

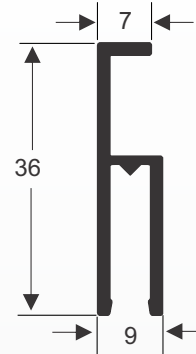

**STL-0643**

Merc. -----

Peso 0,252 kg/m

Descr. -----

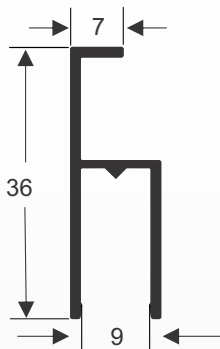

**STL-1348**

Merc. -----

Peso 0,248 kg/m

Descr. -----

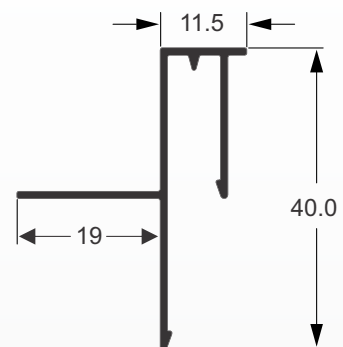

STL-0221

Merc. -----

Peso 0,510 kg/m

Descr. -----

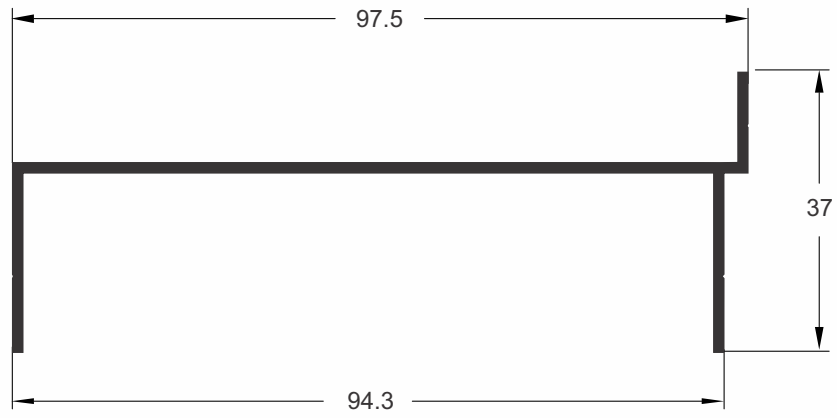

**STL-0728**

Merc. -----

Peso 0,307 kg/m

Descr. -----

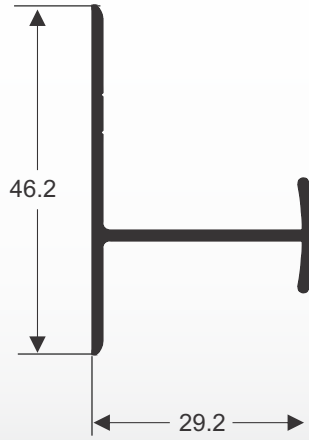

**STL-0217**

Merc. -----

Peso 0,502 kg/m

Descr. -----

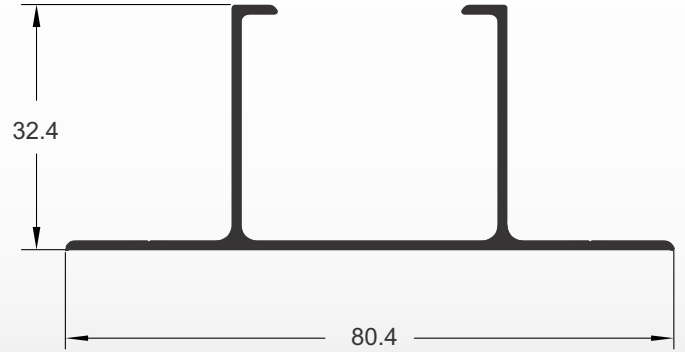

**STL-0166**

Merc. -----

Peso 0,430 kg/m

Descr. -----

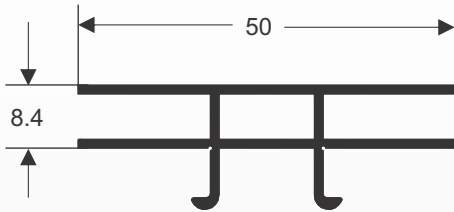

**STL-0127**

Merc. -----

Peso 0,393 kg/m

Descr. -----

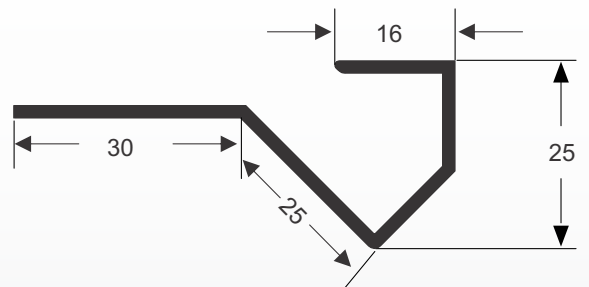

**STL-0147**

Merc. -----

Peso 0,490 kg/m

Descr. -----

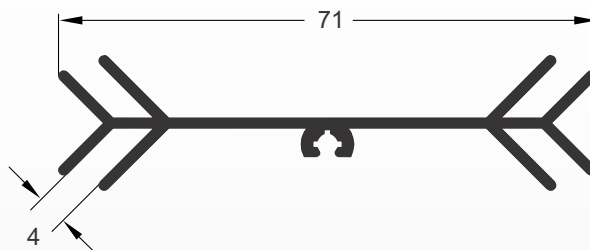



**STL-0026**

Merc. -----

Peso 0,309 kg/m

Descr. -----

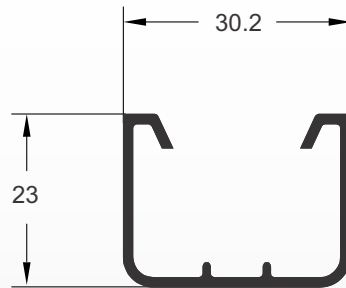

**STL-0128**

Merc. -----

Peso 0,525 kg/m

Descr. -----

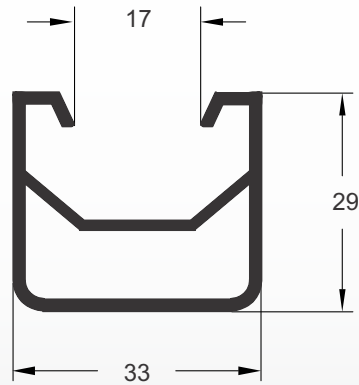

**STL-0125**

Merc. -----

Peso 0,762 kg/m

Descr. -----

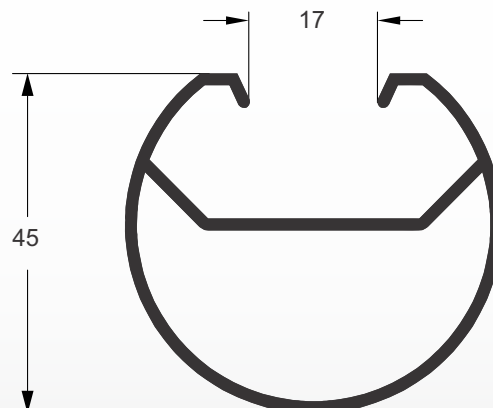

**STL-1041**

Merc. -----

Peso 1,068 kg/m

Descr. Folha

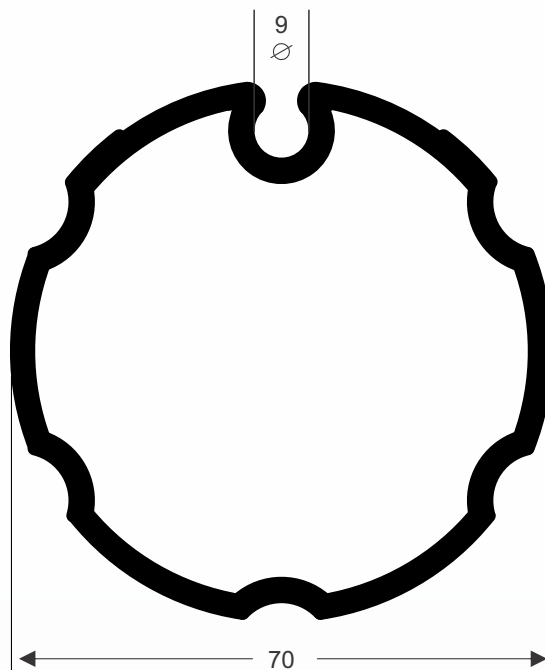

STL-1042

Merc. -----

Peso 1,141 kg/m

Descr. Folha

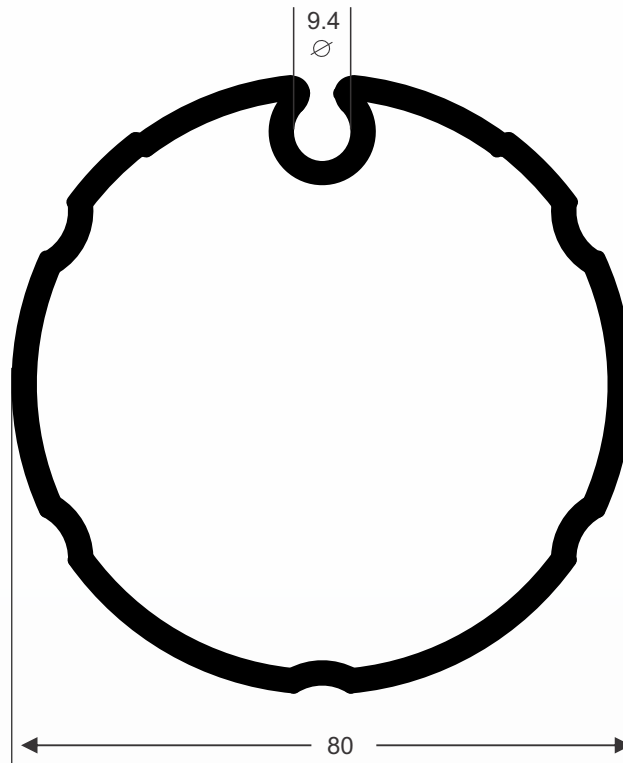

STL-0721

Merc. -----

Peso 1,279 kg/m

Descr. Folha

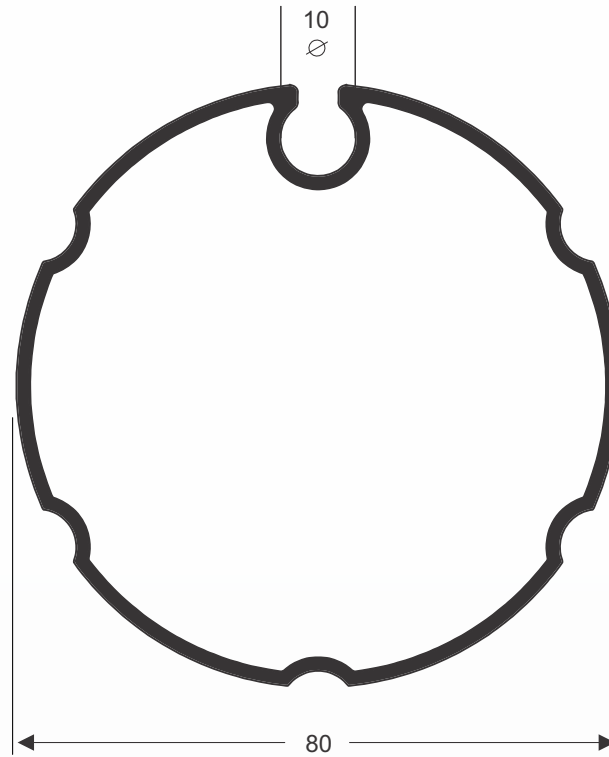

**STL-1332**

Merc. -----

Peso 0,878 kg/m

Descr. -----

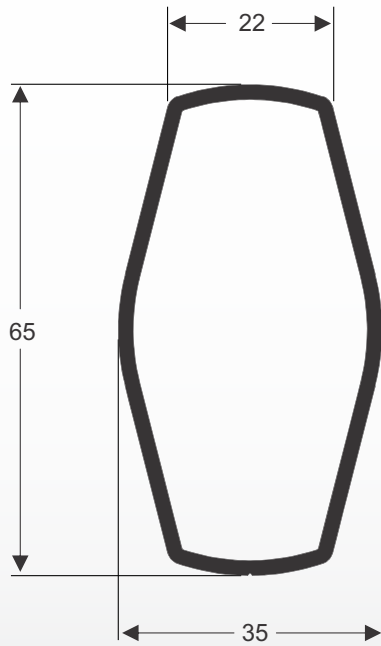

**STL-1333**

Merc. -----

Peso 1,043 kg/m

Descr. Folha

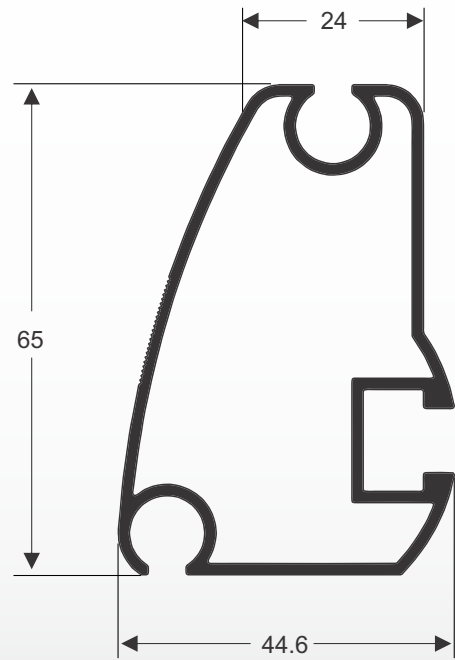

**STL-1334**

Merc. -----

Peso 3,989 kg/m

Descr. -----

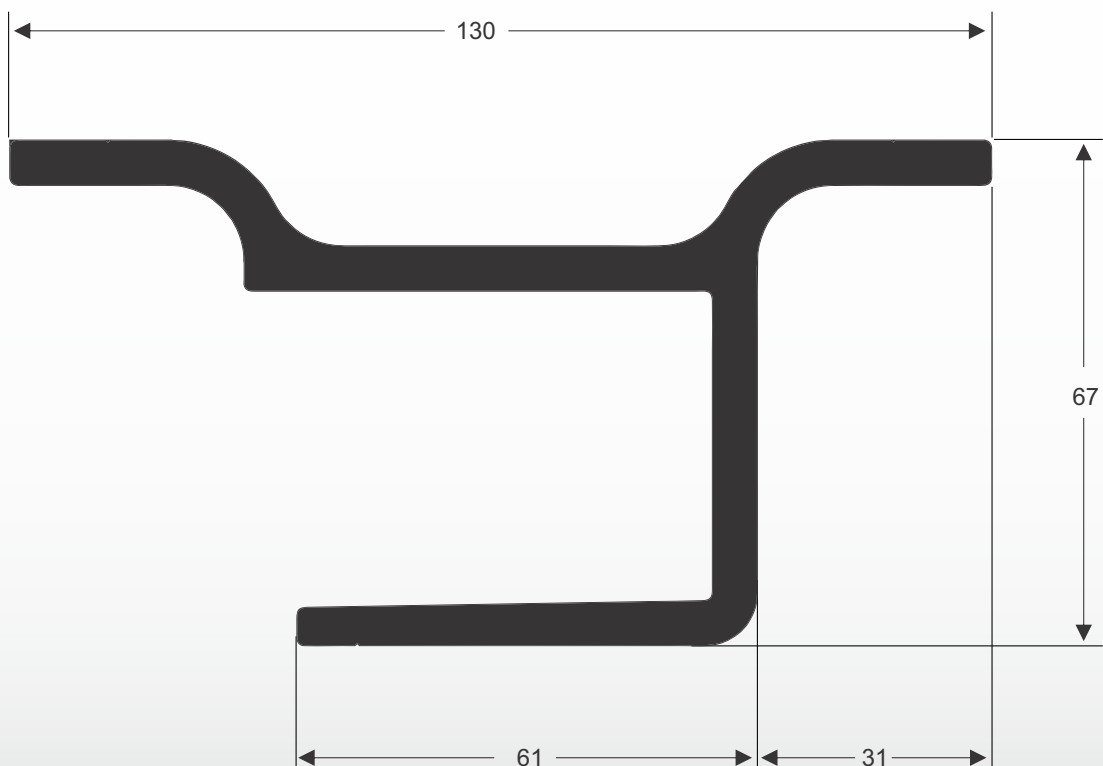



**STL**  
ALUMÍNIO



[stlaluminio.com.br](http://stlaluminio.com.br)



Av. Industrial, 1500 - Distrito Industrial - CEP 08586-150  
Itaquaquecetuba - SP - Tel.: 55+ 11 4233-9012